

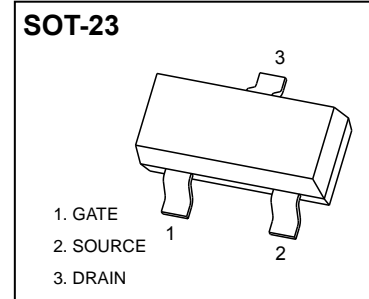

SOT-23 Plastic-Encapsulate MOSFETS

CJ3434 N-Channel MOSFET

| | | |
|---------------|-----------------|-------|
| $V_{(BR)DSS}$ | $R_{DS(on)MAX}$ | I_D |
| 30V | 42 mΩ@10V | 5A |
| | 44 mΩ@4.5V | |
| | 50 mΩ@2.5V | |



FEATURE

- TrenchFET Power MOSFET
- Low $R_{DS(ON)}$
- Typical ESD Protection

APPLICATION

- Ideal for Load Swith and Battery Protection Applications

MARKING

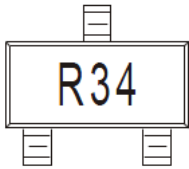

Equivalent Circuit

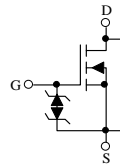

ABSOLUTE MAXIMUM RATINGS ($T_a=25^{\circ}C$ unless otherwise noted)

| Parameter | Symbol | Value | Unit |
|--|-----------------|----------|---------------|
| Drain-Source Voltage | V_{DS} | 30 | V |
| Gate-Source Voltage | V_{GS} | ±10 | V |
| Continuous Drain Current | I_D | 5 | A |
| Pulsed Drain Current | I_{DM}^* | 20 | A |
| Thermal Resistance from Junction to Ambient | $R_{\theta JA}$ | 417 | $^{\circ}C/W$ |
| Operation Junction and Storage Temperature Range | T_J, T_{STG} | -55~+150 | $^{\circ}C$ |
| Lead Temperature for Soldering Purposes(1/8" from case for 10 s) | T_L | 260 | $^{\circ}C$ |

*Repetitive rating: Pluse width limited by junction temperature.

MOSFET ELECTRICAL CHARACTERISTICS

$T_a=25\text{ }^\circ\text{C}$ unless otherwise specified

| Parameter | Symbol | Test Condition | Min | Typ | Max | Unit |
|--------------------------------------|---------------|---|-----|------|----------|------------|
| STATIC PARAMETERS | | | | | | |
| Drain-source breakdown voltage | $V_{(BR)DSS}$ | $V_{GS} = 0V, I_D = 250\mu A$ | 30 | | | V |
| Zero gate voltage drain current | I_{DSS} | $V_{DS} = 30V, V_{GS} = 0V$ | | | 1 | μA |
| Gate-body leakage current | I_{GSS} | $V_{GS} = \pm 10V, V_{DS} = 0V$ | | | ± 10 | μA |
| Gate threshold voltage(note 1) | $V_{GS(th)}$ | $V_{DS} = V_{GS}, I_D = 250\mu A$ | 0.6 | | 1 | V |
| Drain-source on-resistance (note 1) | $R_{DS(on)}$ | $V_{GS} = 10V, I_D = 5A$ | | 32.5 | 42 | m Ω |
| | | $V_{GS} = 4.5V, I_D = 5A$ | | 35 | 44 | m Ω |
| | | $V_{GS} = 2.5V, I_D = 4A$ | | 35 | 50 | m Ω |
| Forward tranconductance (note 1) | g_{FS} | $V_{DS} = 5V, I_D = 4A$ | | 15 | | S |
| Diode forward voltage (note 1) | V_{SD} | $I_S = 1A, V_{GS} = 0V$ | | | 1 | V |
| DYNAMIC PARAMETERS (note2) | | | | | | |
| Input Capacitance | C_{iss} | $V_{DS} = 15V, V_{GS} = 0V, f = 1MHz$ | | 245 | | pF |
| Output Capacitance | C_{oss} | | | 35 | | pF |
| Reverse Transfer Capacitance | C_{rss} | | | 20 | | pF |
| SWITCHING PARAMETERS (note 2) | | | | | | |
| Turn-on delay time | $t_{d(on)}$ | $V_{DD} = 15V, V_{GS} = 10V$ $R_L = 3.75\Omega, R_{GEN} = 3\Omega$ | | 2 | | ns |
| Turn-on rise time | t_r | | | 3.5 | | ns |
| Turn-off delay time | $t_{d(off)}$ | | | 22 | | ns |
| Turn-off fall time | t_f | | | 3.5 | | ns |
| Total Gate Charge | Q_g | $V_{DS} = 15V, V_{GS} = 10V, I_D = 4A$ | | | 10 | nC |
| Gate-Source Charge | Q_{gs} | | | 0.5 | | nC |
| Gate-Drain Charge | Q_{gd} | | | 1 | | nC |

- Notes :**
1. Pulse Test : Pulse width $\leq 300\mu s$, duty cycle $\leq 0.5\%$.
 2. Guaranteed by design, not subject to production testing.

Typical Characteristics

Output Characteristics

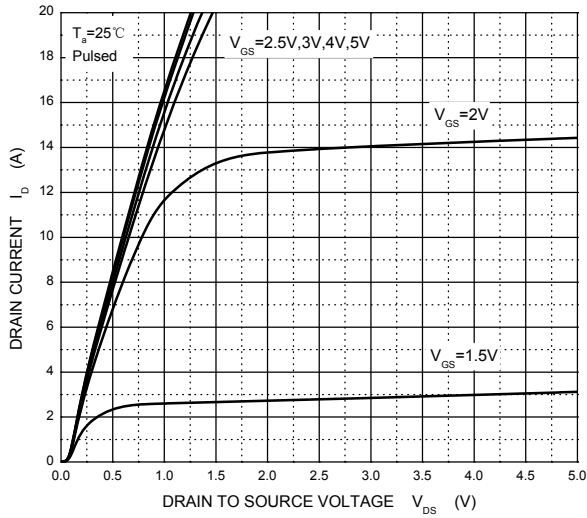

Transfer Characteristics

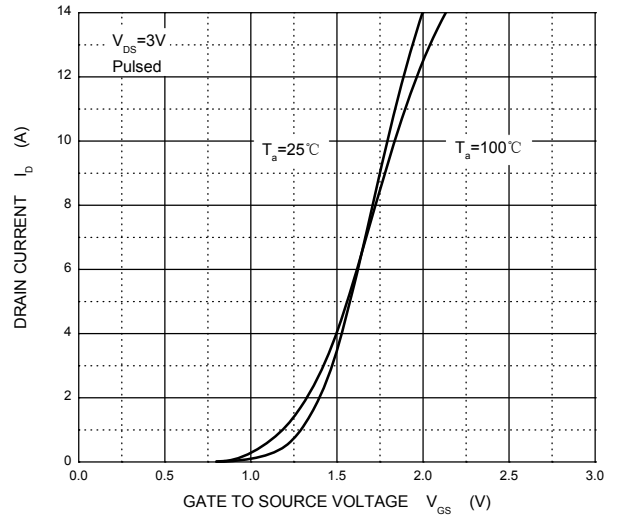

$R_{DS(ON)}$ — I_D

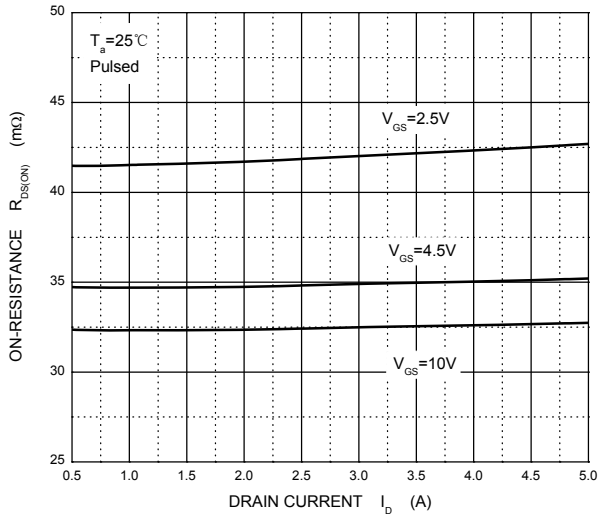

$R_{DS(ON)}$ — V_{GS}

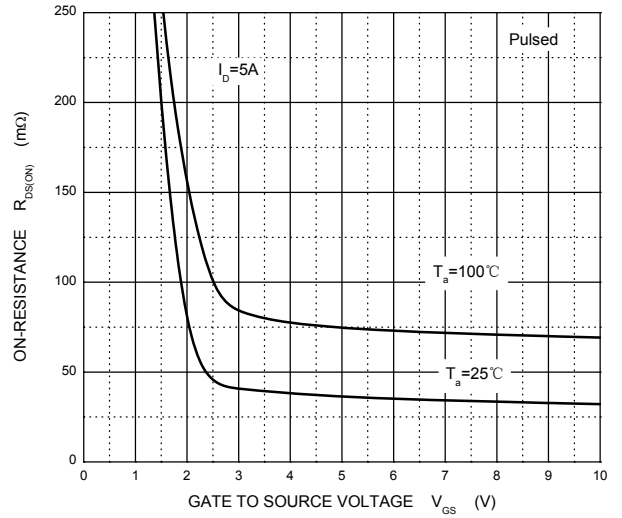

I_S — V_{SD}

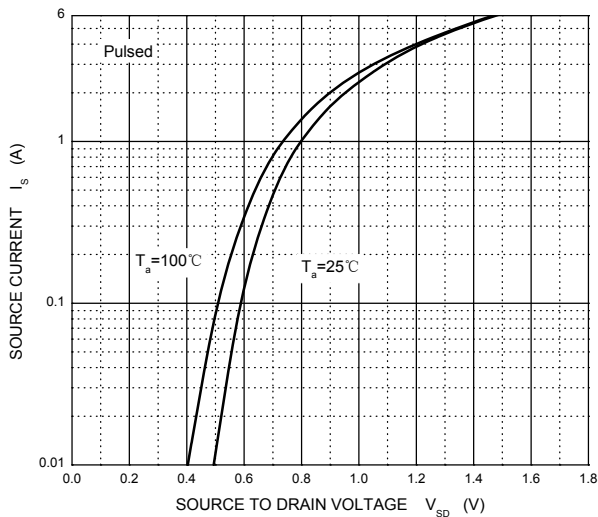

Threshold Voltage

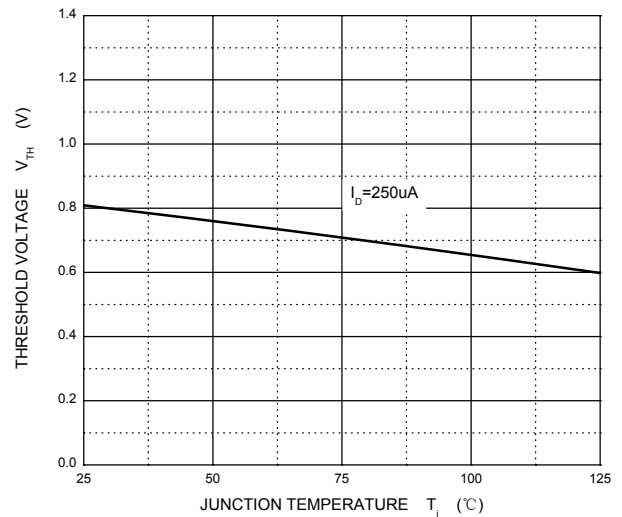

SOT-23 Package Outline Dimensions



| Symbol | Dimensions In Millimeters | | Dimensions In Inches | |
|--------|---------------------------|-------|----------------------|-------|
| | Min | Max | Min | Max |
| A | 0.900 | 1.150 | 0.035 | 0.045 |
| A1 | 0.000 | 0.100 | 0.000 | 0.004 |
| A2 | 0.900 | 1.050 | 0.035 | 0.041 |
| b | 0.300 | 0.500 | 0.012 | 0.020 |
| c | 0.080 | 0.150 | 0.003 | 0.006 |
| D | 2.800 | 3.000 | 0.110 | 0.118 |
| E | 1.200 | 1.400 | 0.047 | 0.055 |
| E1 | 2.250 | 2.550 | 0.089 | 0.100 |
| e | 0.950 TYP | | 0.037 TYP | |
| e1 | 1.800 | 2.000 | 0.071 | 0.079 |
| L | 0.550 REF | | 0.022 REF | |
| L1 | 0.300 | 0.500 | 0.012 | 0.020 |
| θ | 0° | 8° | 0° | 8° |

SOT-23 Suggested Pad Layout



Note:

1. Controlling dimension: in millimeters.
2. General tolerance: $\pm 0.05\text{mm}$.
3. The pad layout is for reference purposes only.

NOTICE

JSCJ reserves the right to make modifications, enhancements, improvements, corrections or other changes without further notice to any product herein. JSCJ does not assume any liability arising out of the application or use of any product described herein.

SOT-23 Tape and Reel

SOT-23 Embossed Carrier Tape

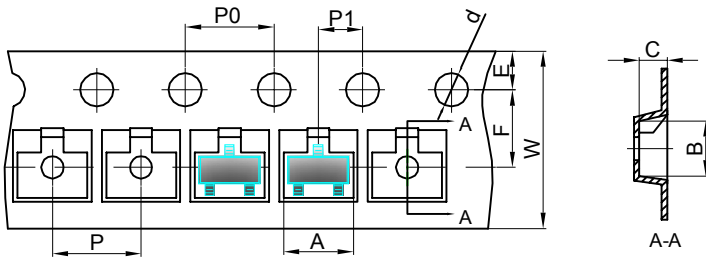

Packaging Description:

SOT-23 parts are shipped in tape. The carrier tape is made from a dissipative (carbon filled) polycarbonate resin. The cover tape is a multilayer film (Heat Activated Adhesive in nature) primarily composed of polyester film, adhesive layer, sealant, and anti-static sprayed agent. These reeled parts in standard option are shipped with 3,000 units per 7" or 17.8cm diameter reel. The reels are clear in color and is made of polystyrene plastic (anti-static coated).

| Dimensions are in millimeter | | | | | | | | | | |
|------------------------------|------|------|------|-------|------|------|------|------|------|------|
| Pkg type | A | B | C | d | E | F | P0 | P | P1 | W |
| SOT-23 | 3.15 | 2.77 | 1.22 | Ø1.50 | 1.75 | 3.50 | 4.00 | 4.00 | 2.00 | 8.00 |

SOT-23 Tape Leader and Trailer

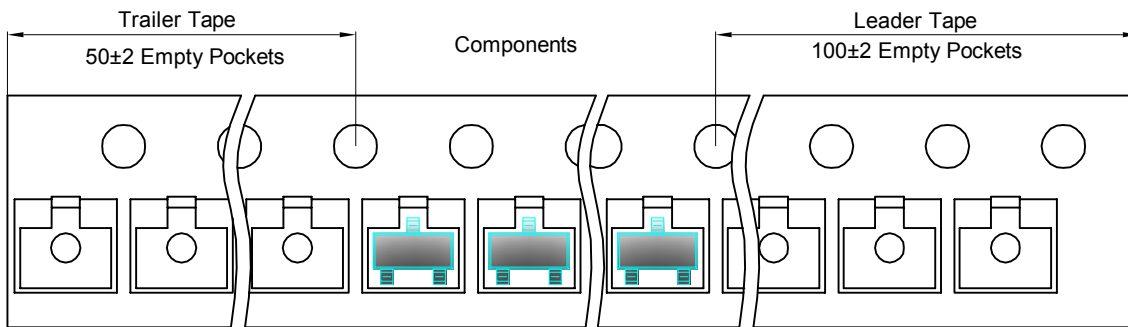

SOT-23 Reel

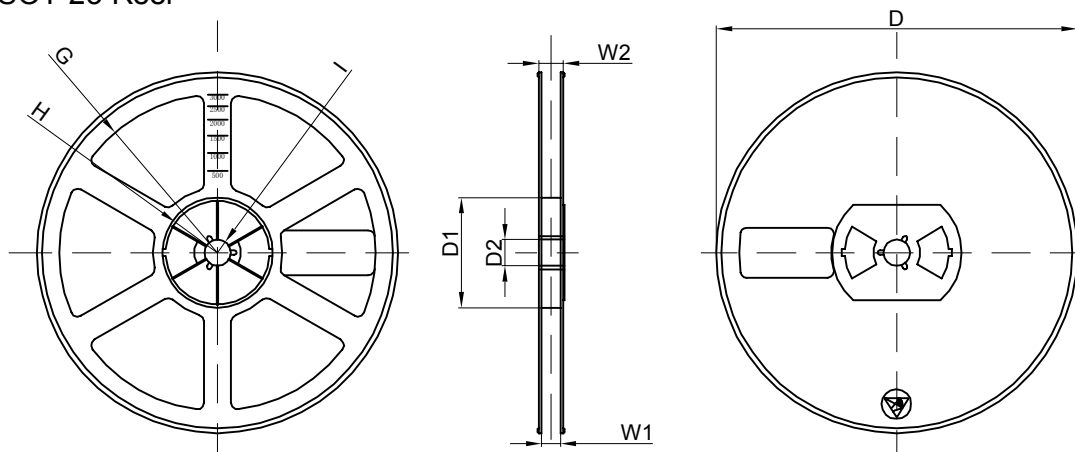

| Dimensions are in millimeter | | | | | | | | |
|------------------------------|---------|-------|-------|--------|--------|-------|------|-------|
| Reel Option | D | D1 | D2 | G | H | I | W1 | W2 |
| 7" Dia | Ø178.00 | 54.40 | 13.00 | R78.00 | R25.60 | R6.50 | 9.50 | 12.30 |

| REEL | Reel Size | Box | Box Size(mm) | Carton | Carton Size(mm) | G.W.(kg) |
|----------|-----------|------------|--------------|-------------|-----------------|----------|
| 3000 pcs | 7 inch | 30,000 pcs | 203×203×195 | 120,000 pcs | 438×438×220 | |